

מורא

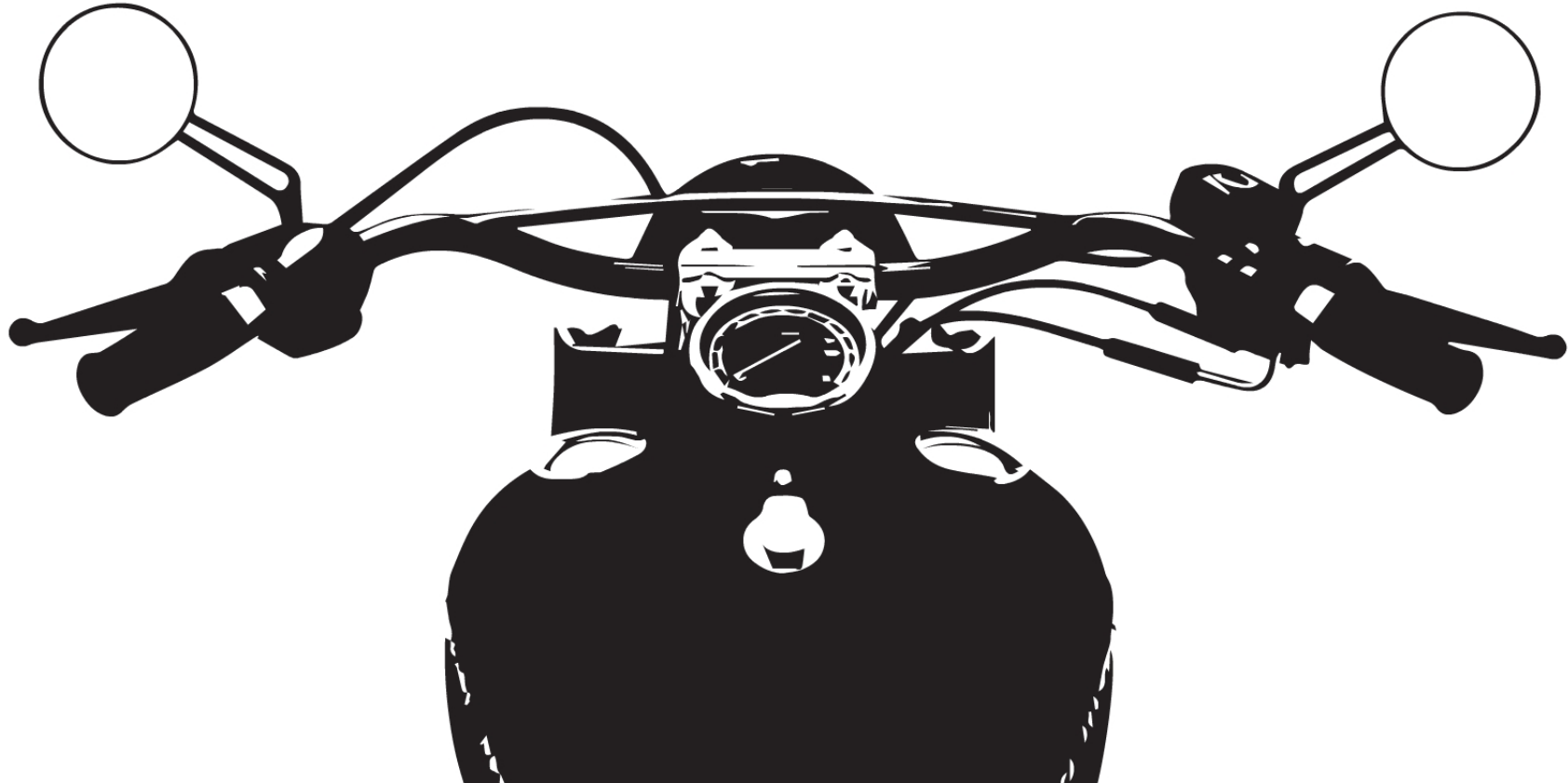

“... pull over **all the time** ...”

“... **shout** directions at me.”



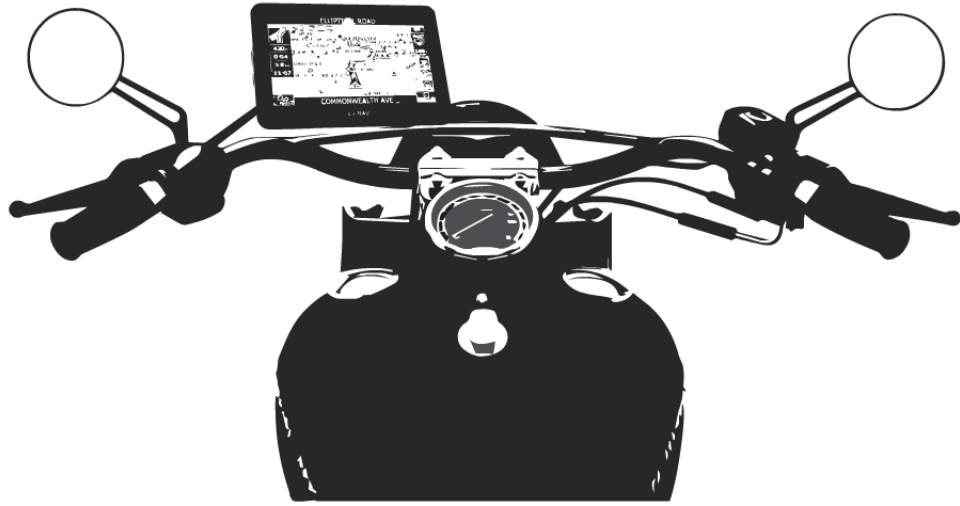

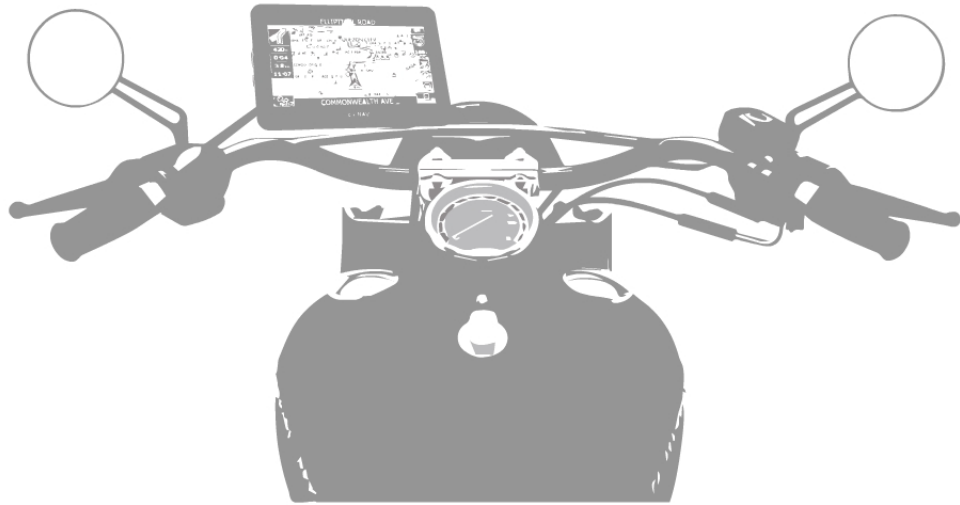

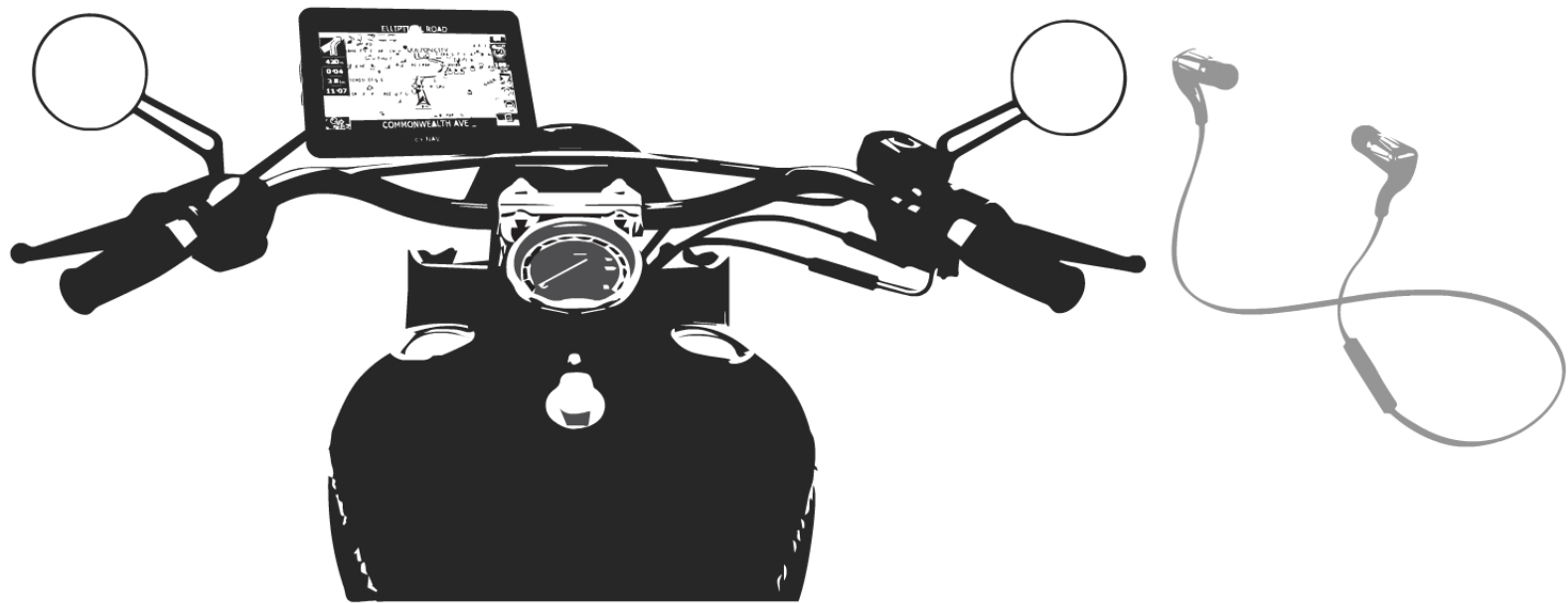



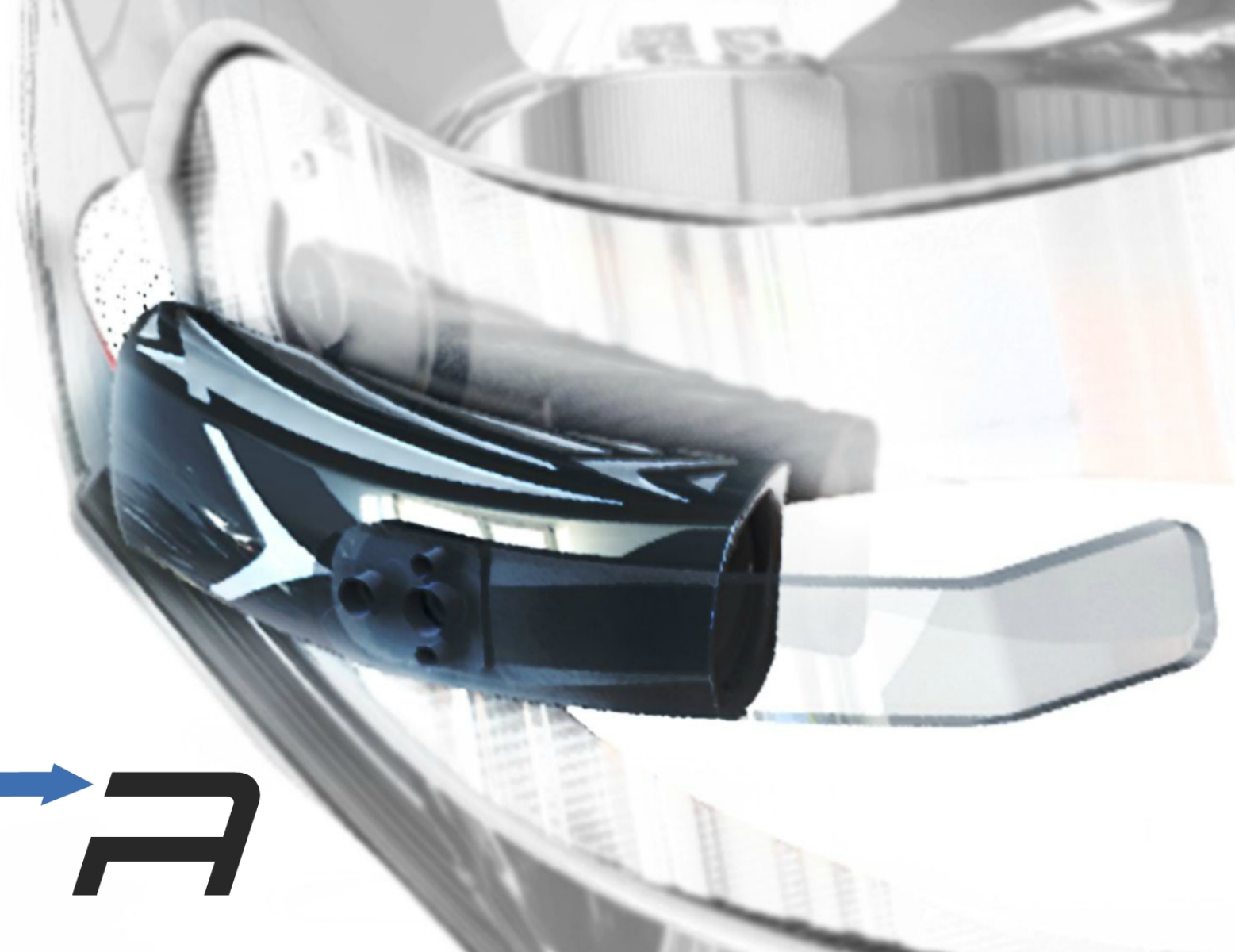

MIRA



**Mount
Mira**



**Choose
Destination**



Ride!



**Mount
Mira**



**Choose
Destination**



Ride!

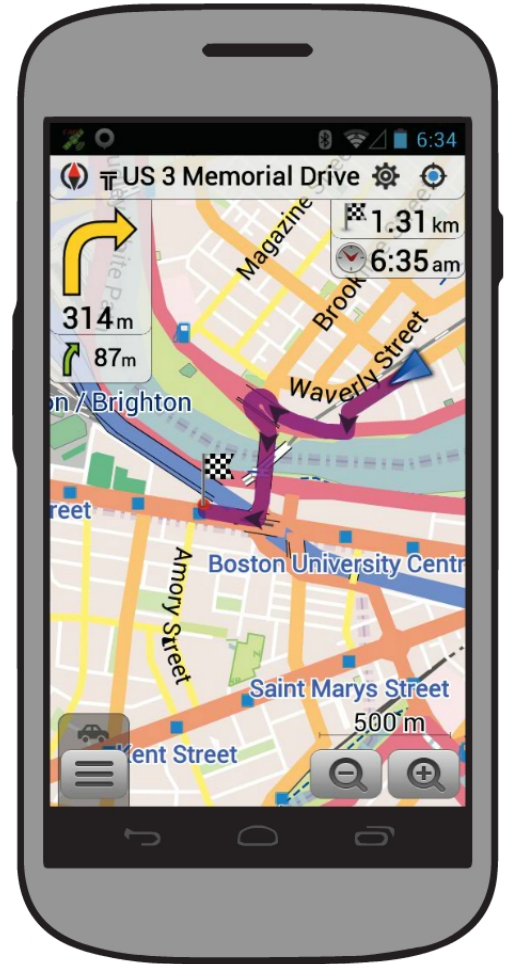
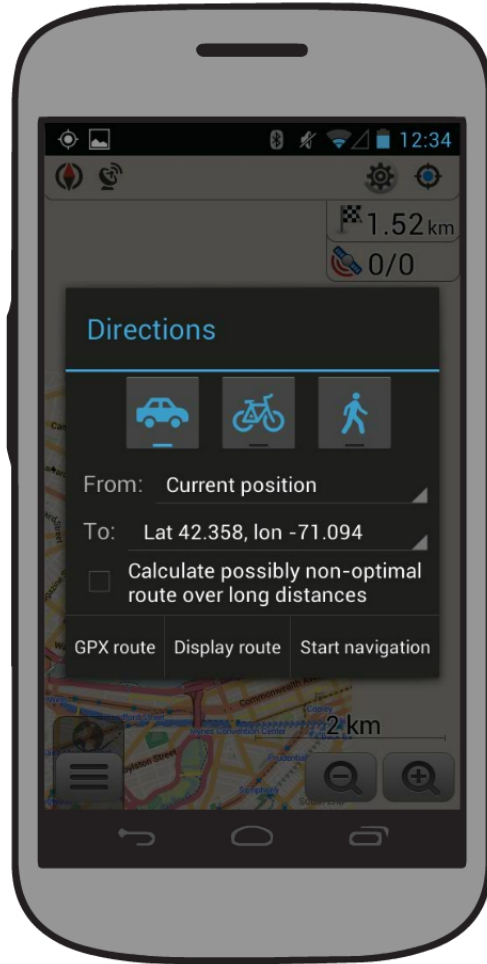
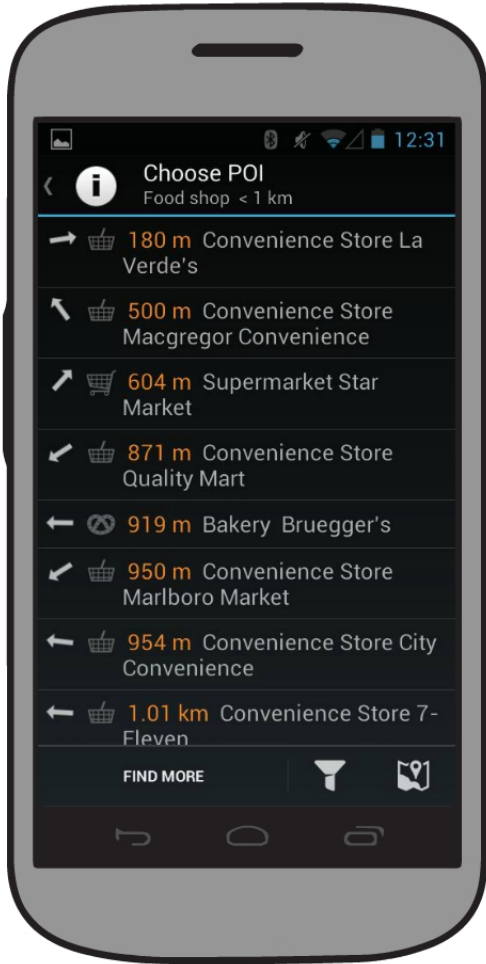

1

**Mount
Mira**

2

**Choose
Destination**

3

Ride!

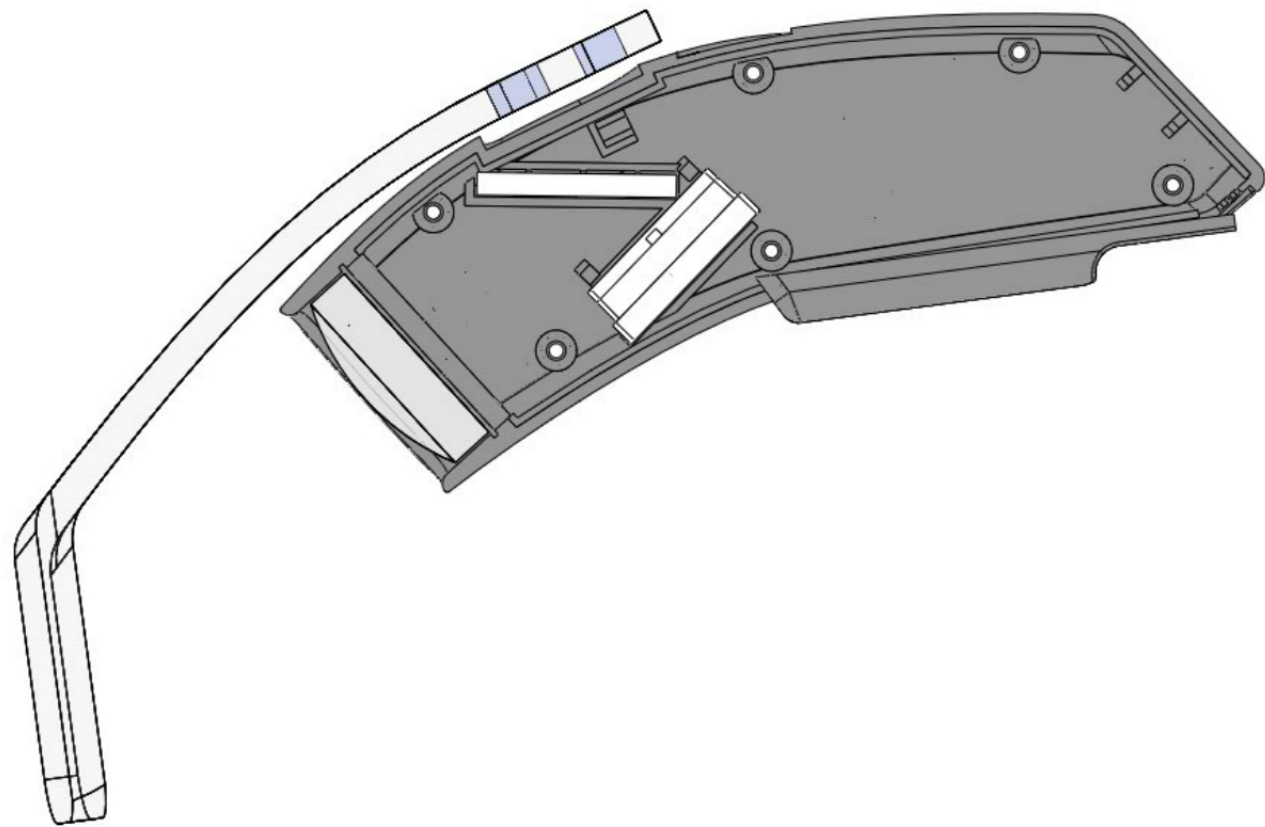

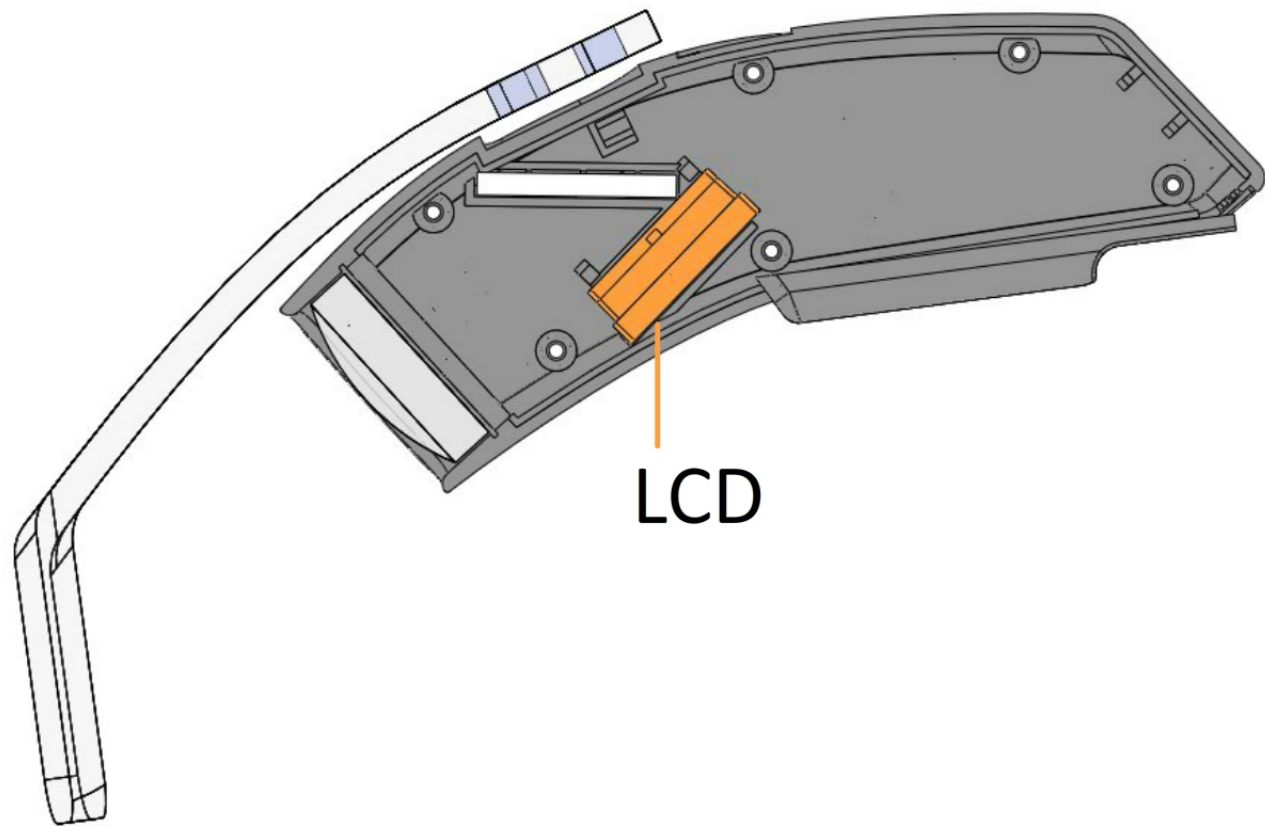

LCD

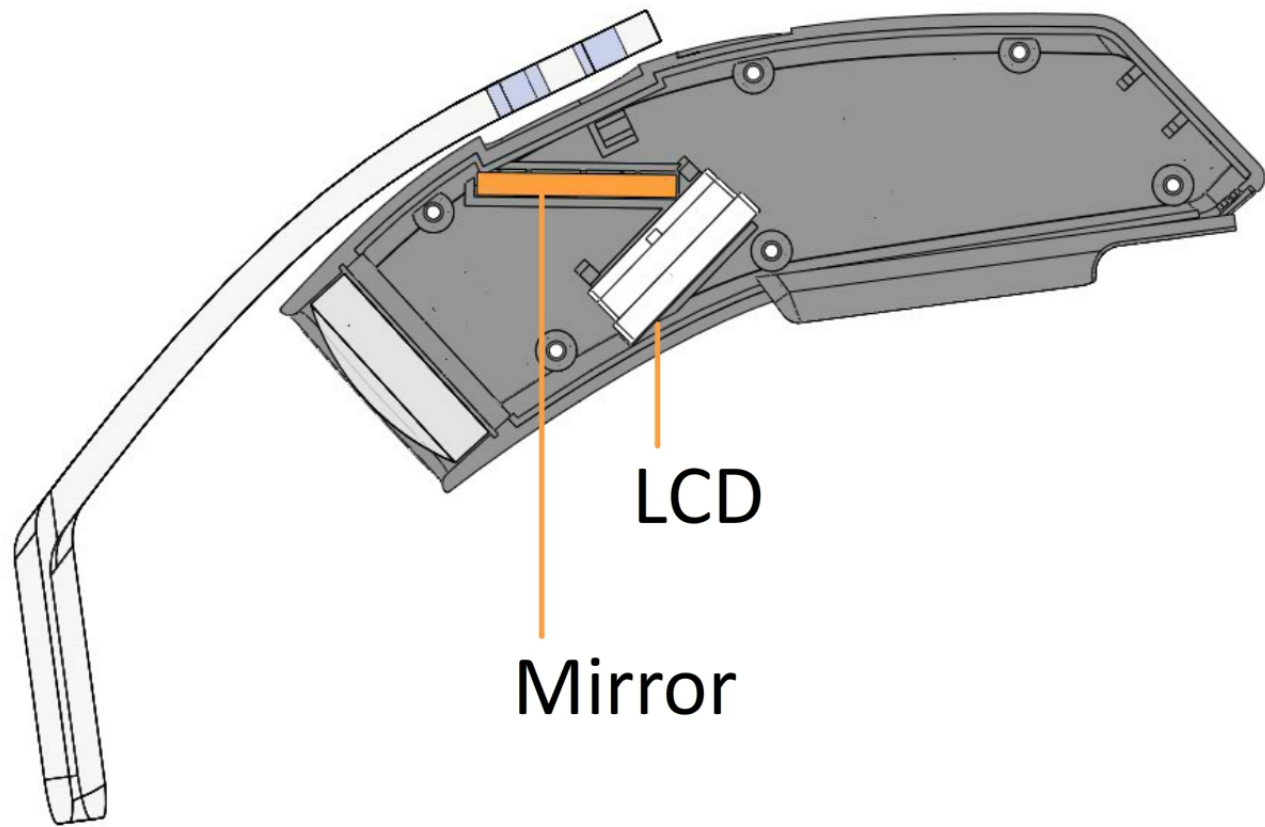

Mirror

LCD

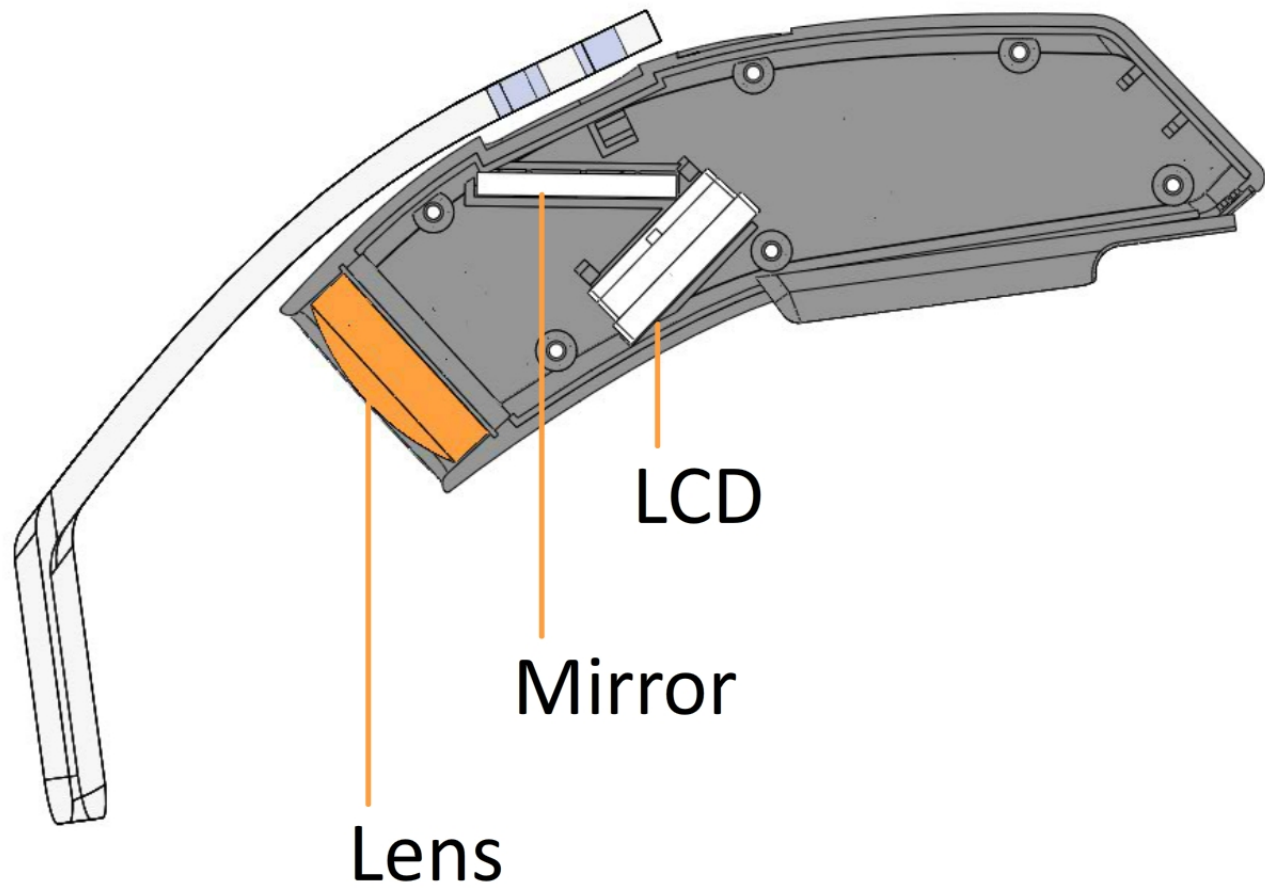

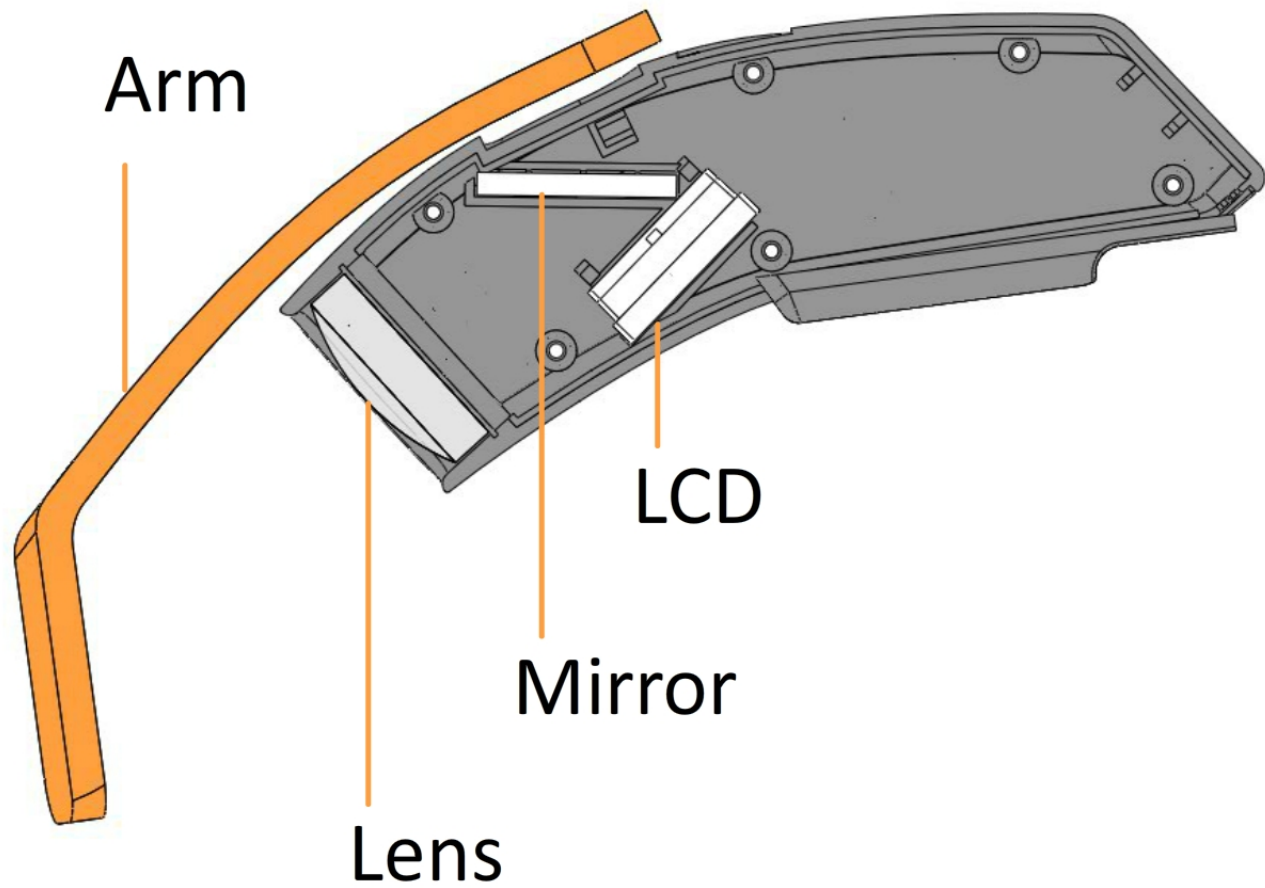

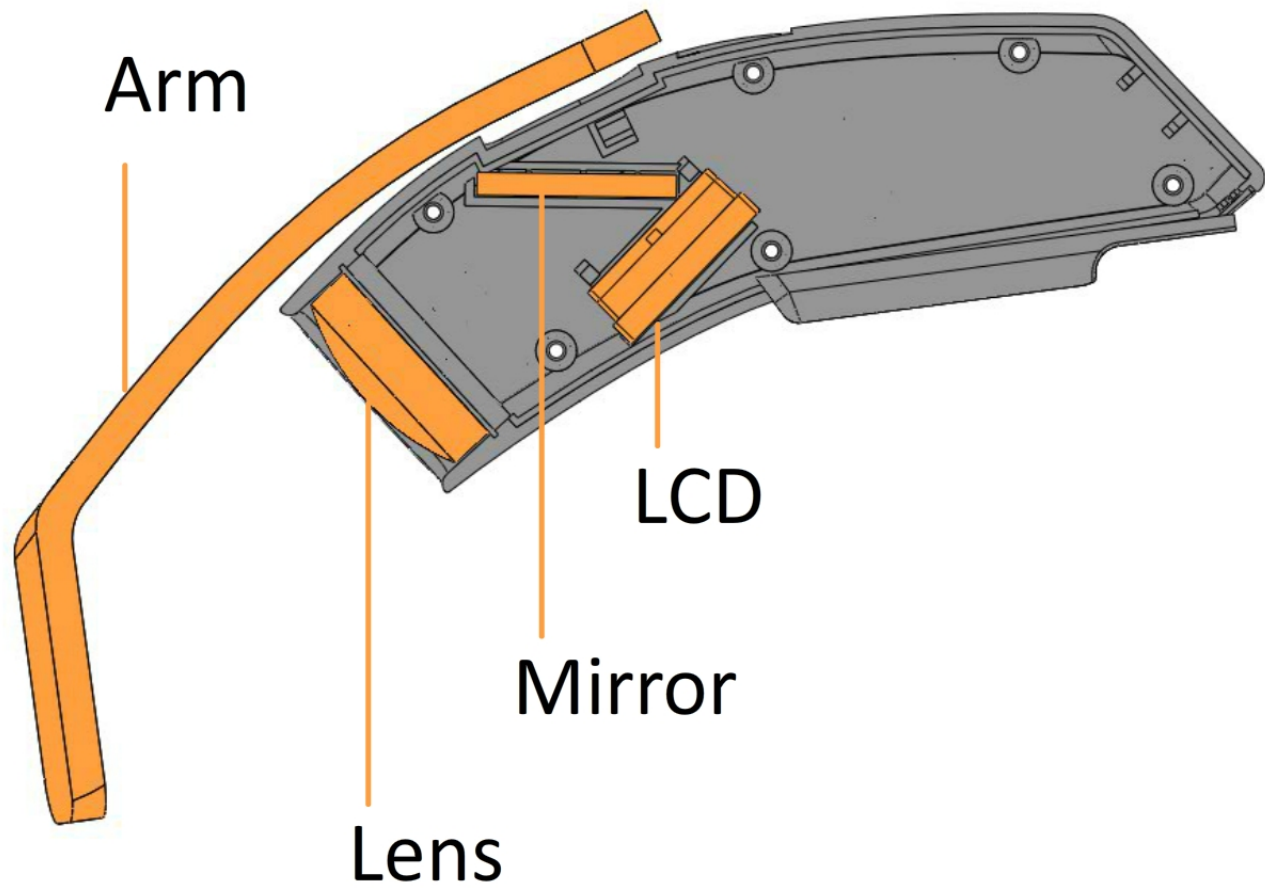

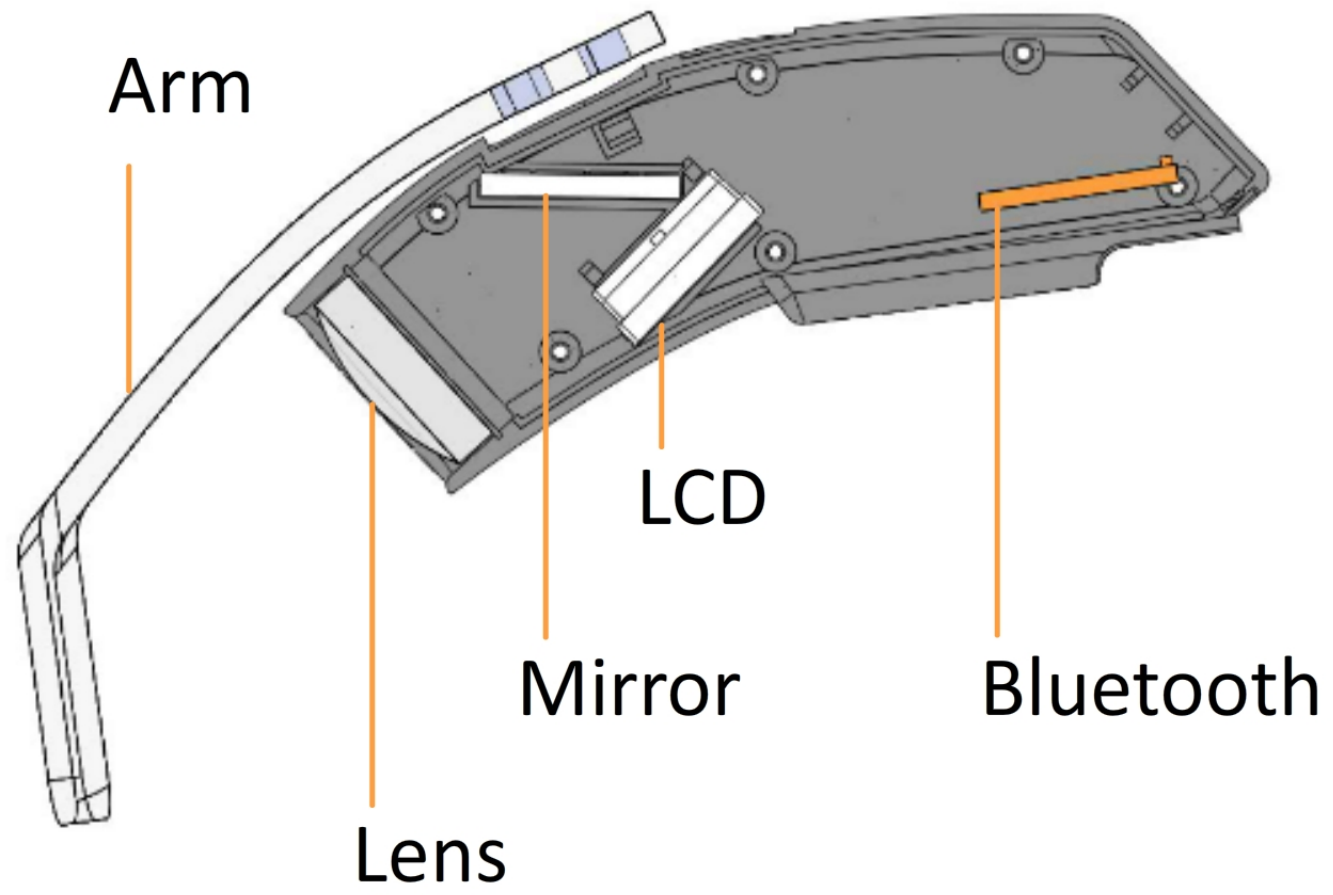

Arm

LCD

Mirror

Bluetooth

Lens

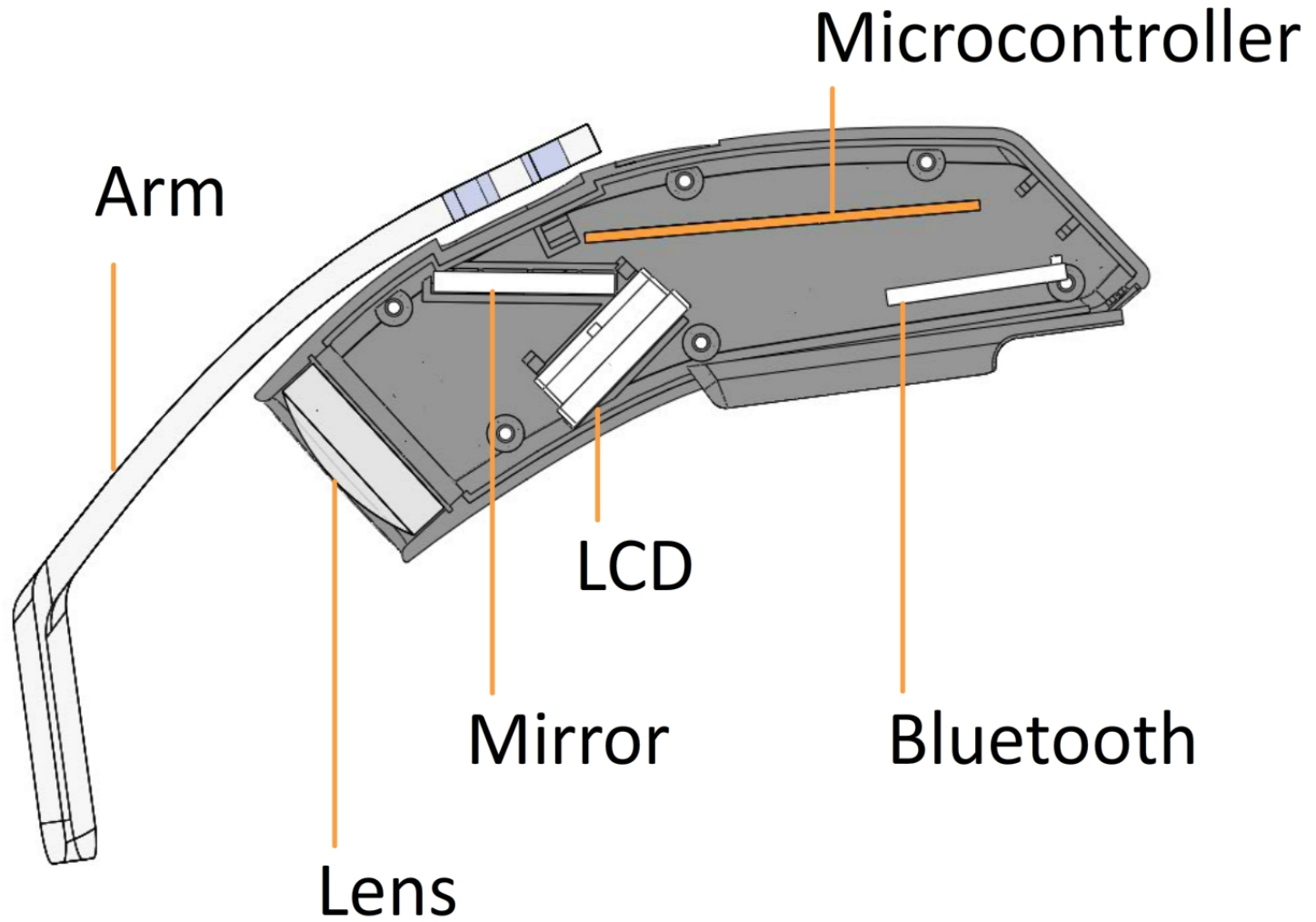

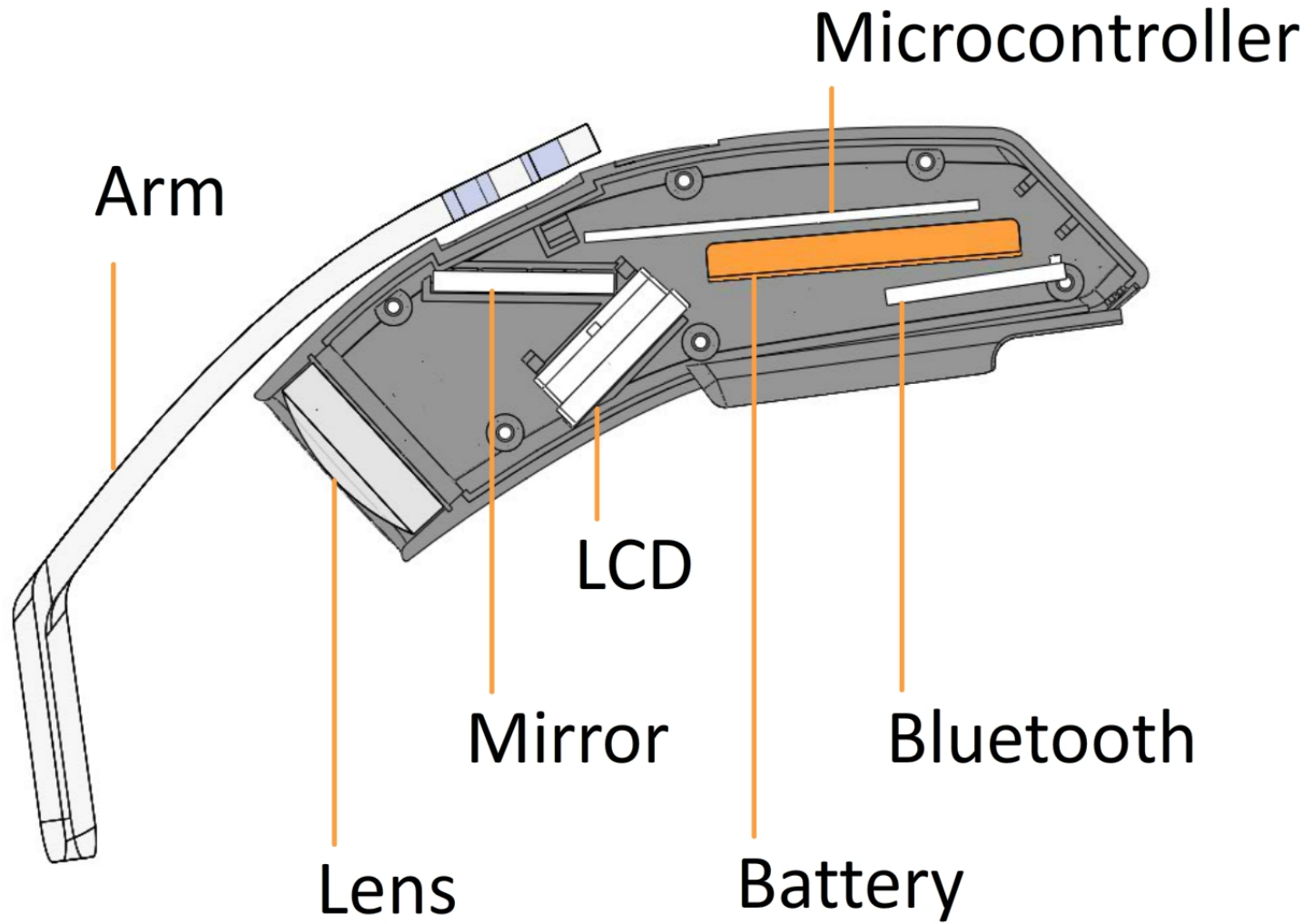

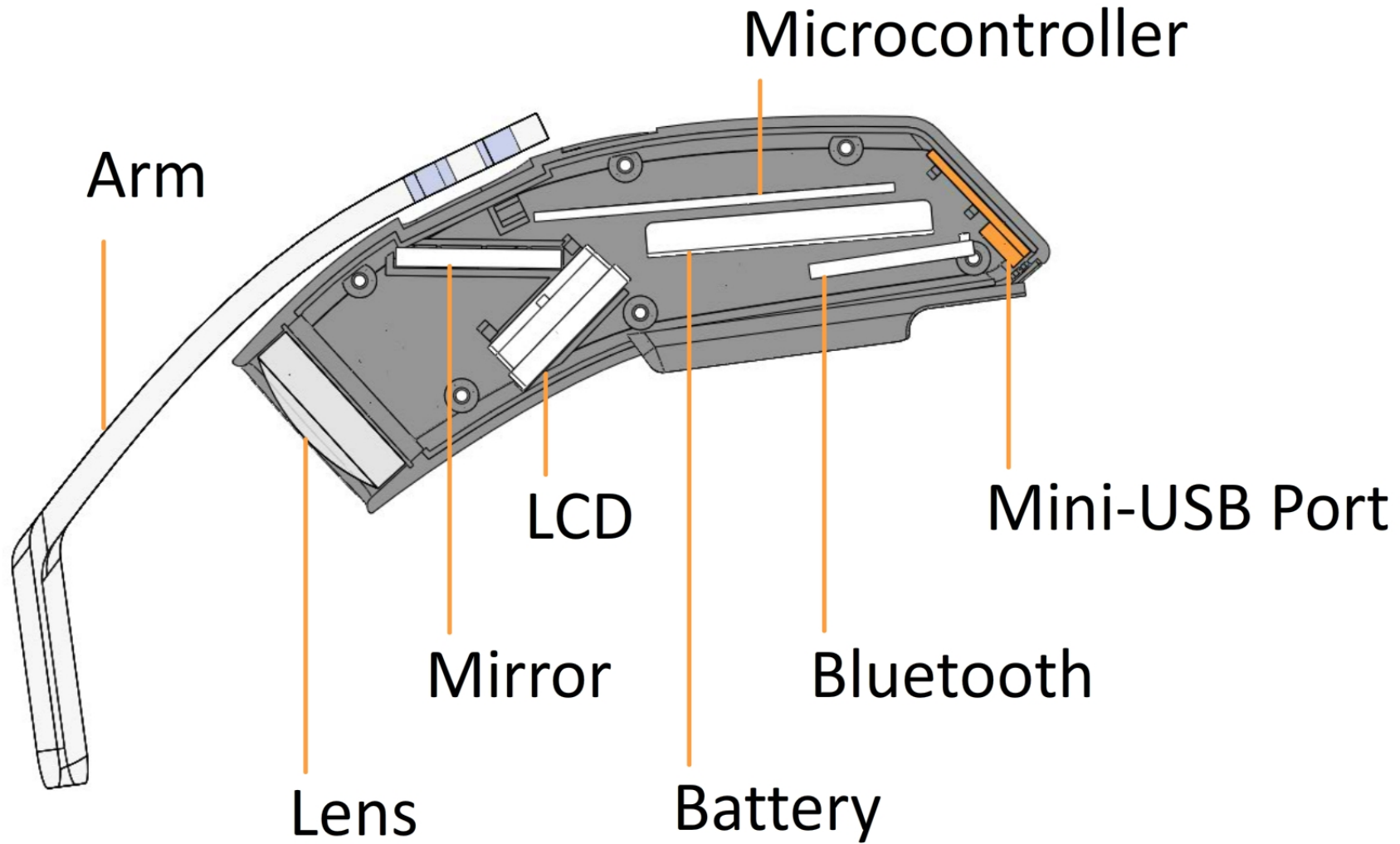

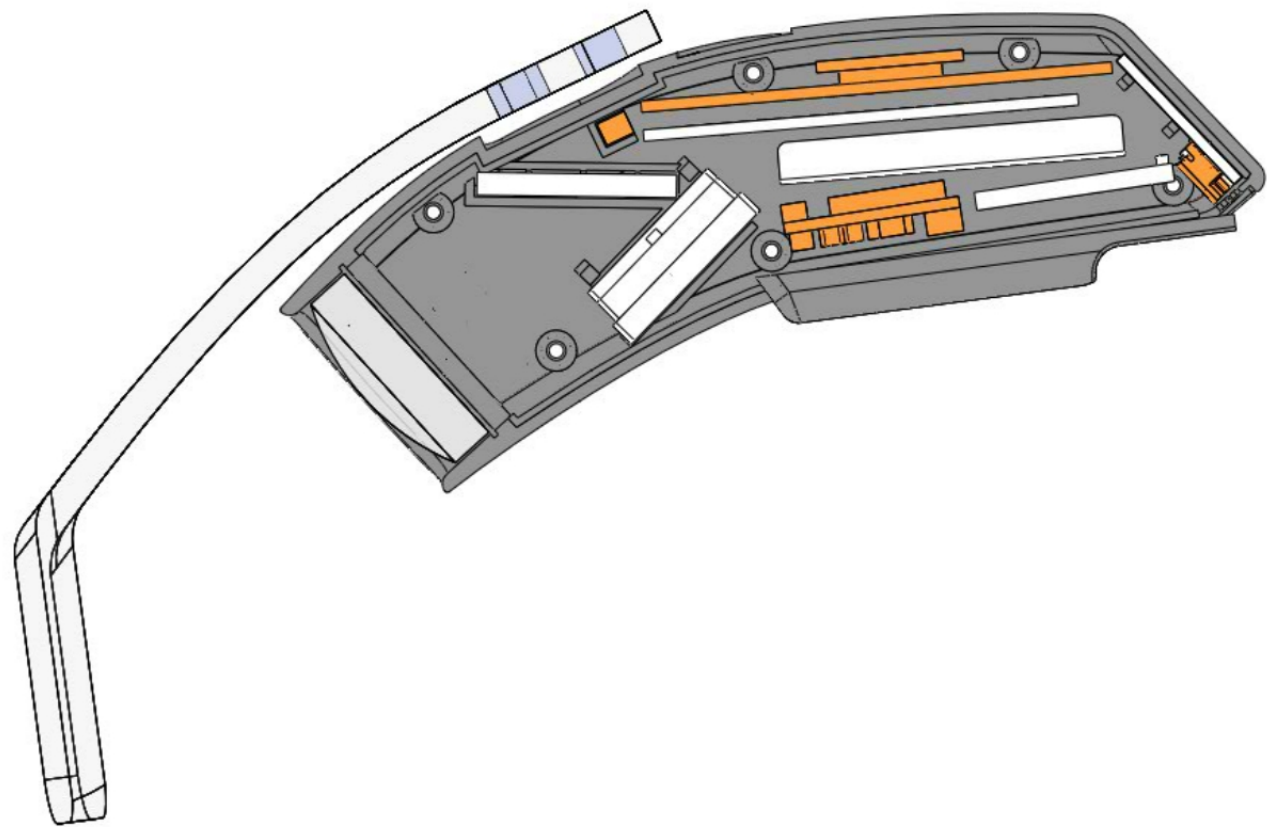

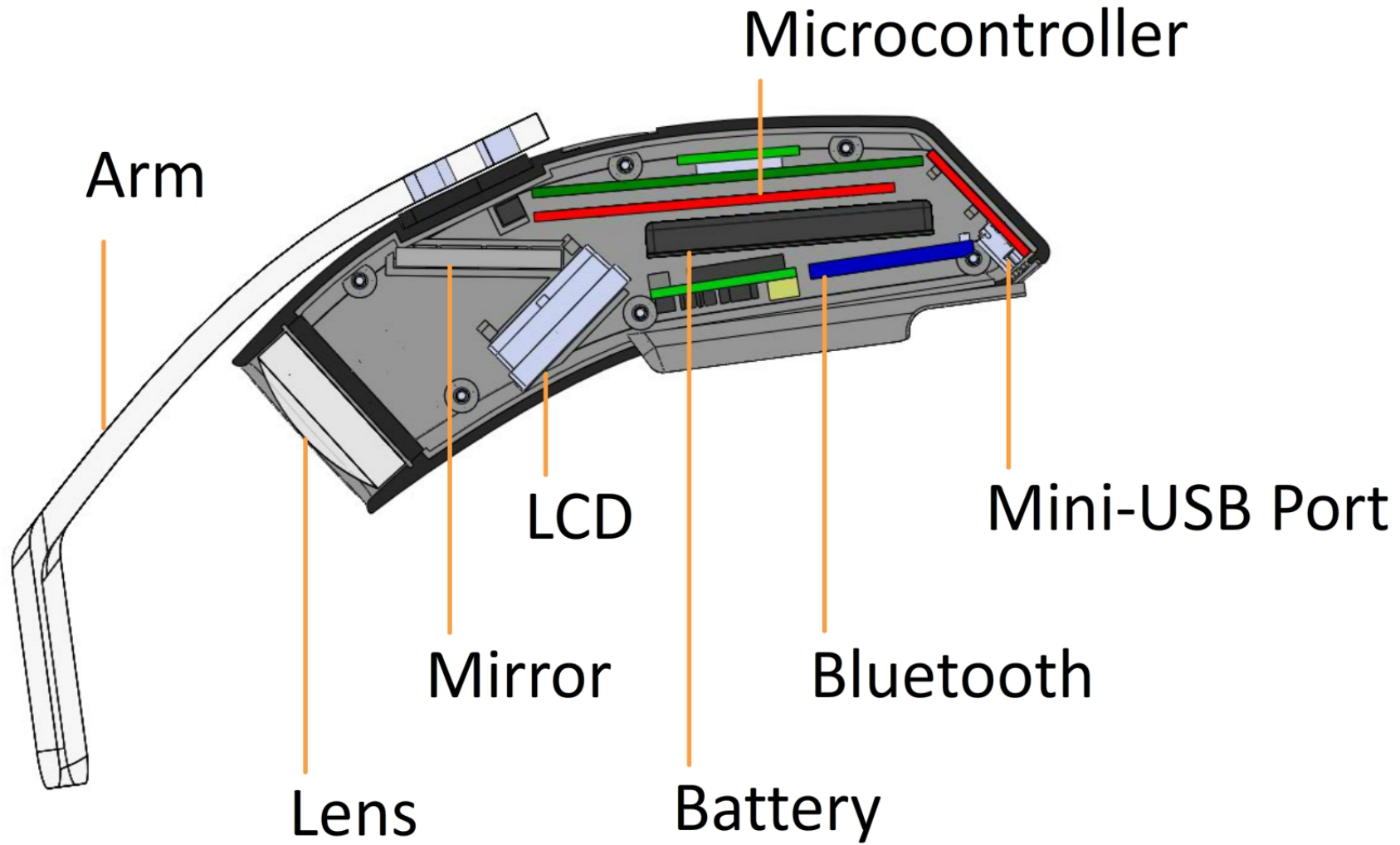

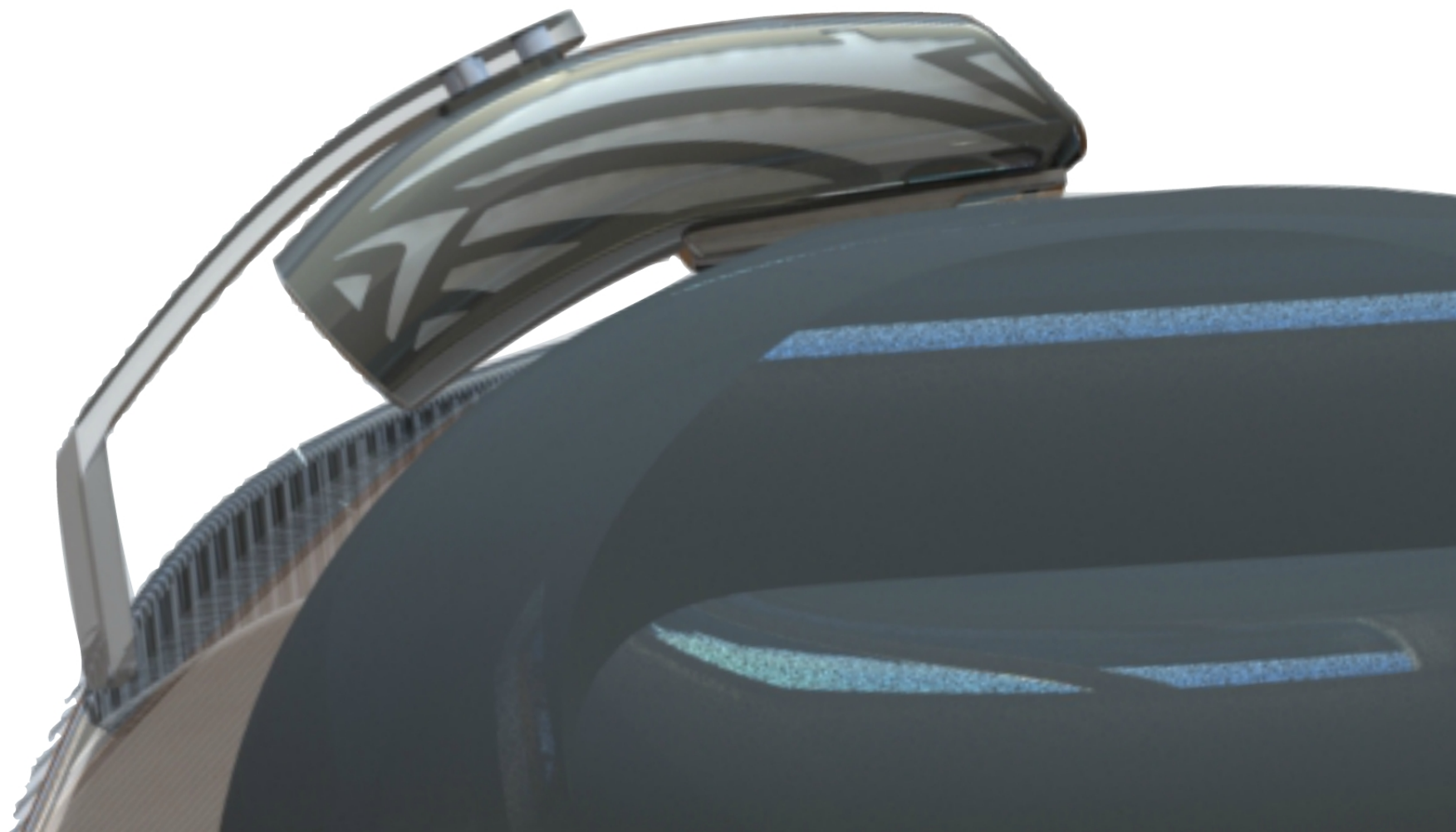

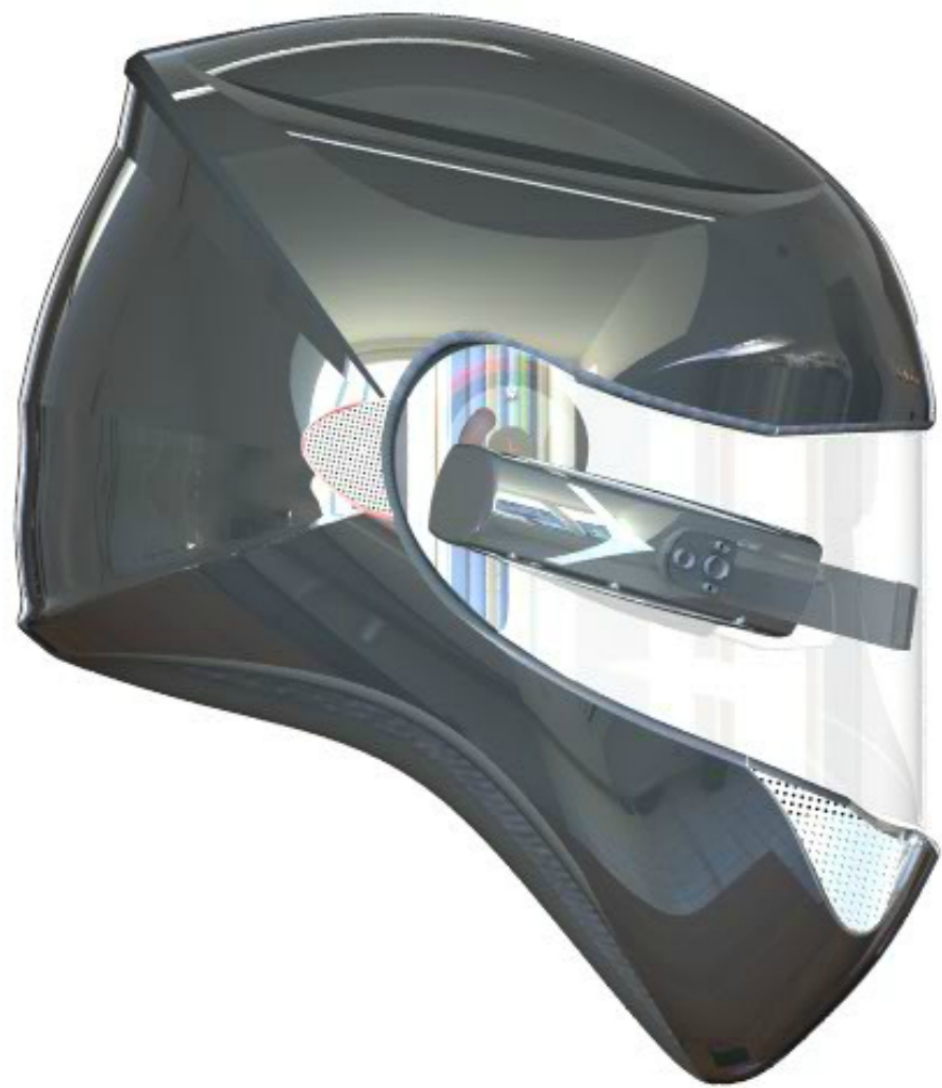

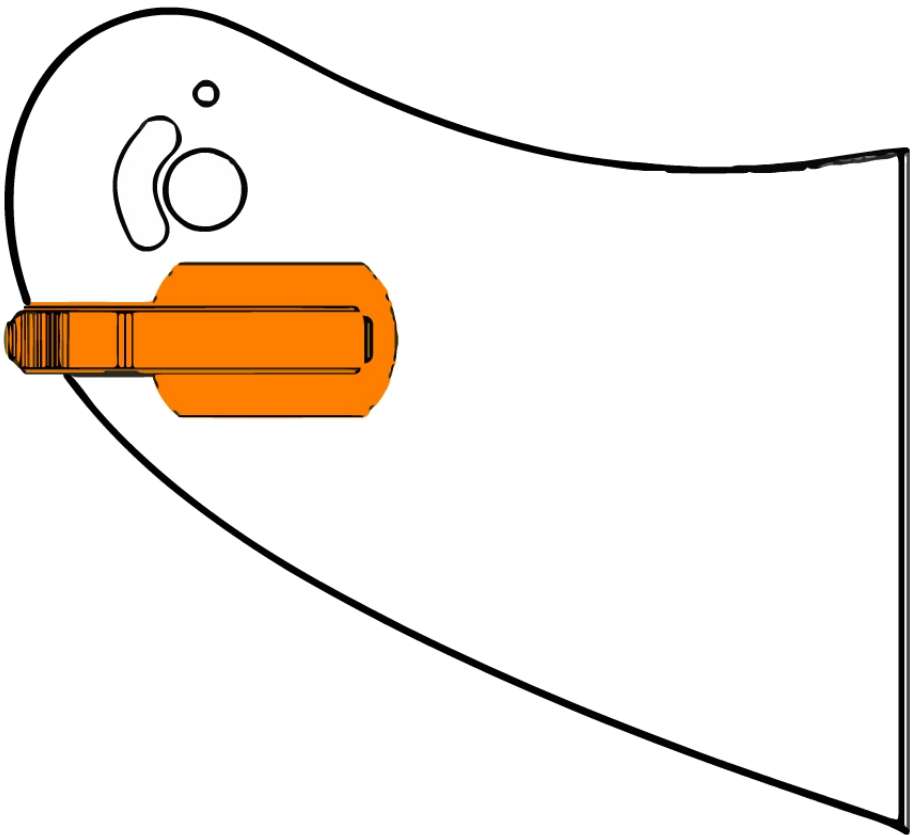

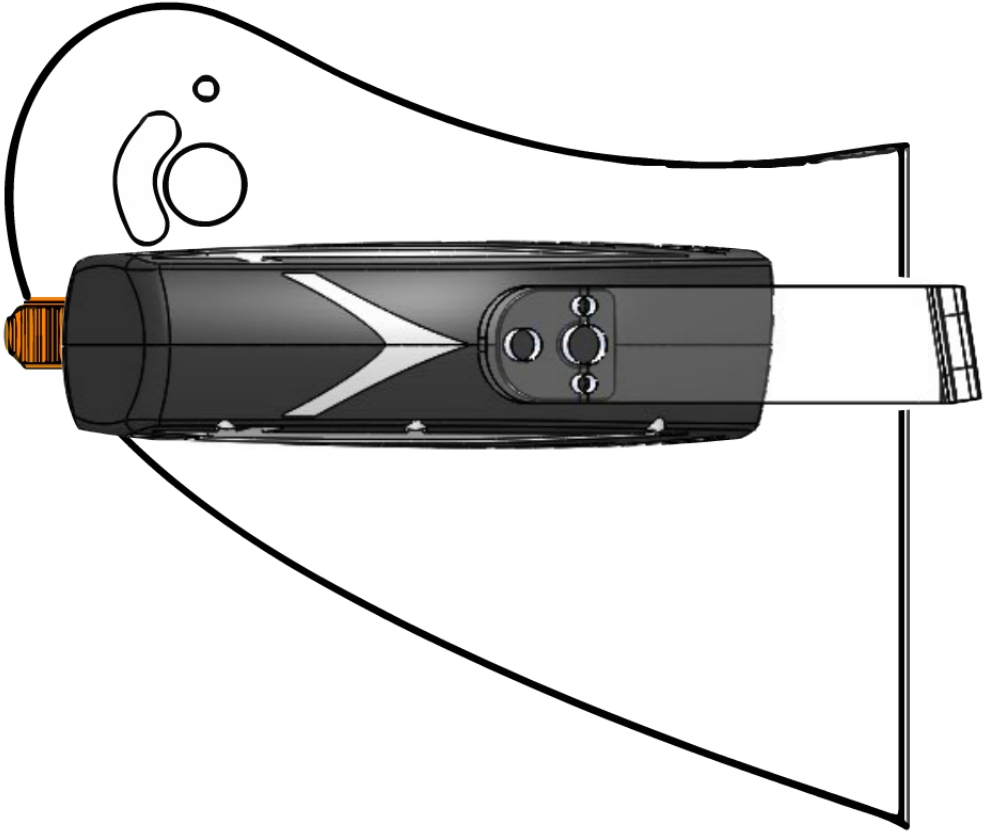











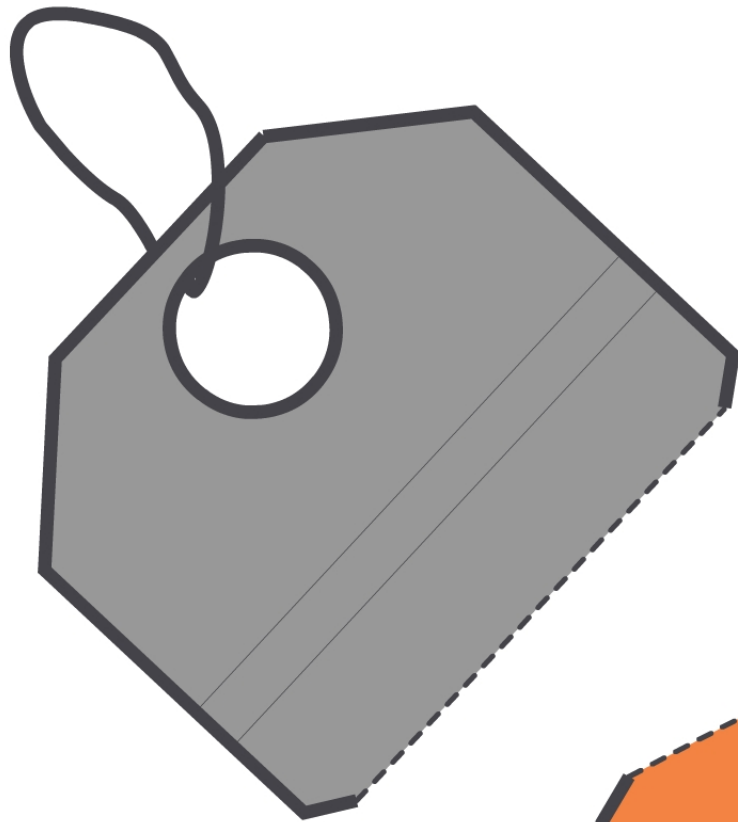

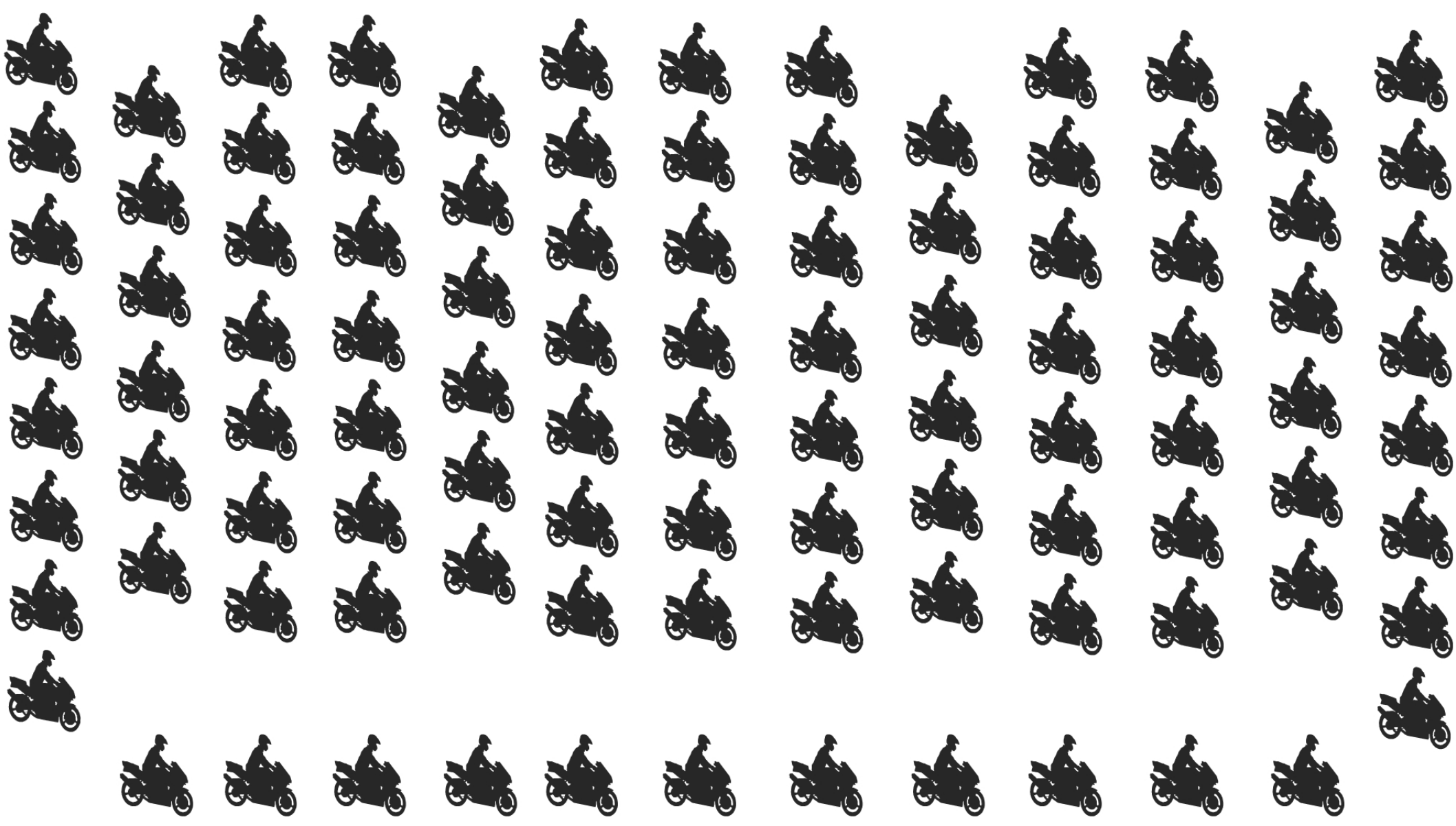





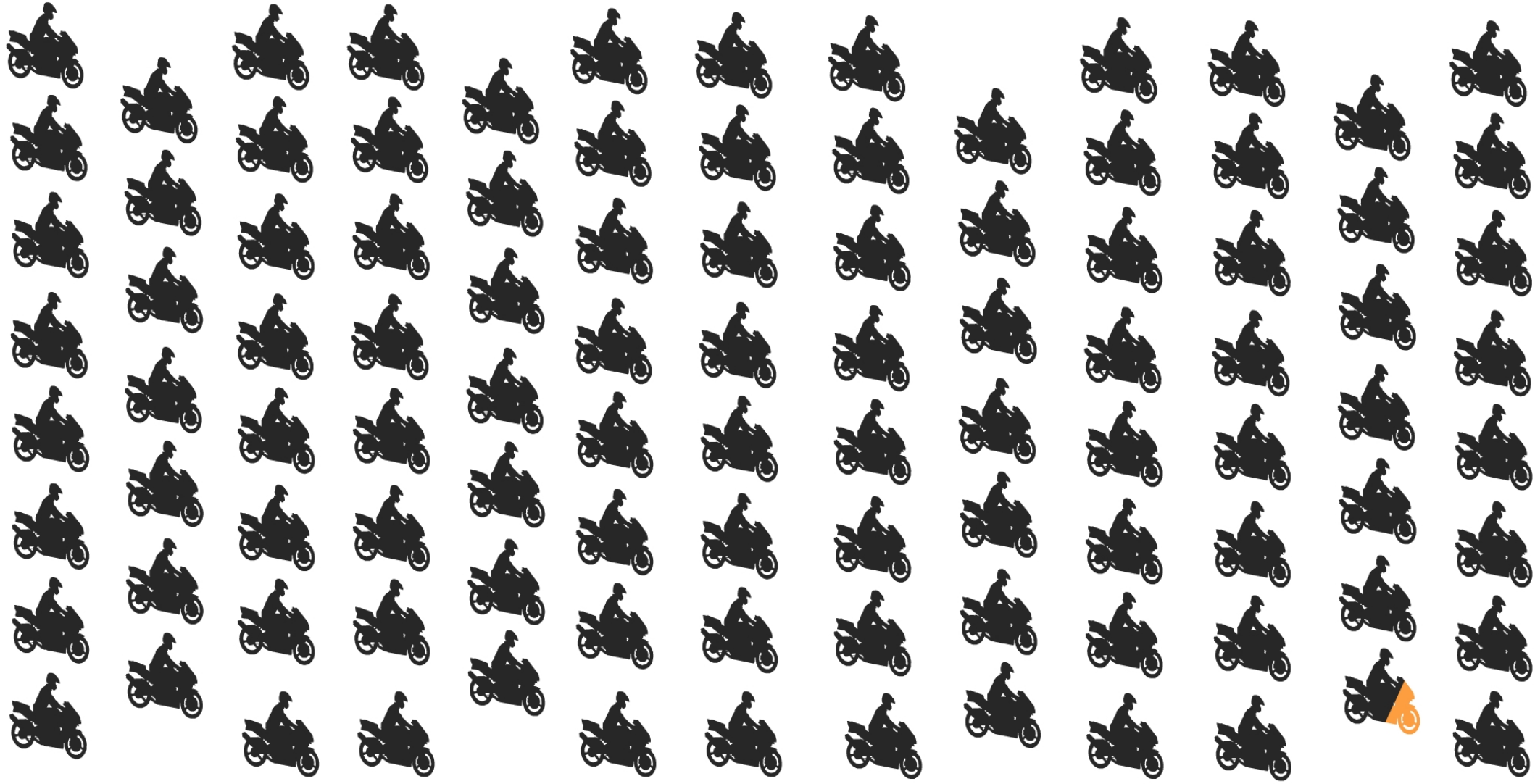



2014

2015

2016

2017

2018

2019

initial \$220k



2014

2015

2016

2017

2018

2019

start selling

initial \$220k



2014

2015

2016

2017

2018

2019

initial \$220k

start selling

break-even



2014

2015

2016

2017

2018

2019

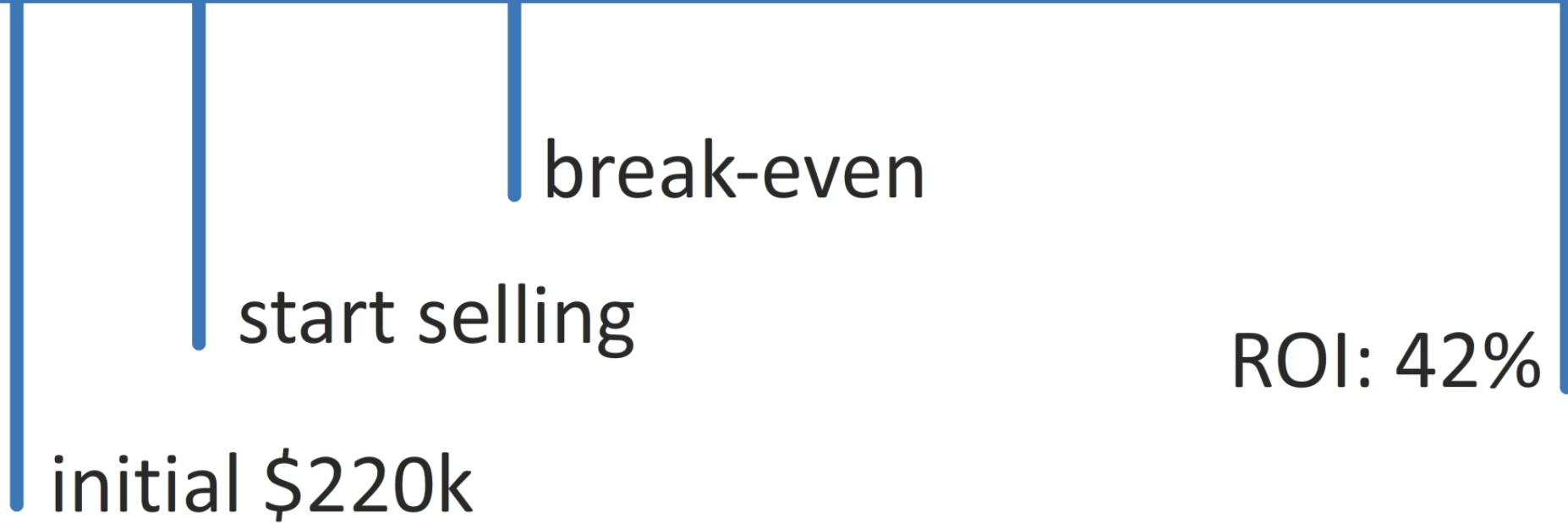

initial \$220k

start selling

break-even

ROI: 42%

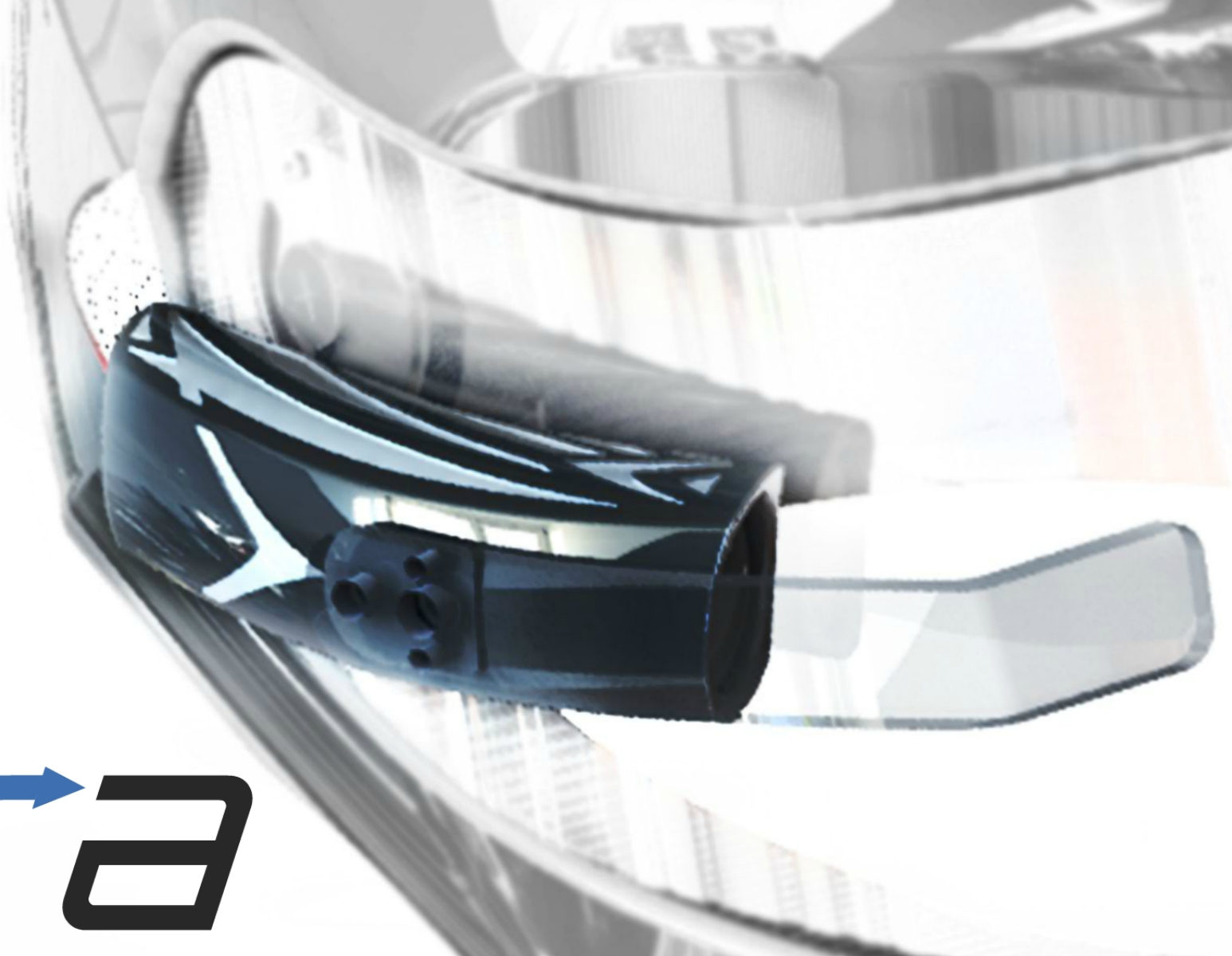

mira

Thank you



David Wallace

Juhan Sonin

Danny Braunstein

Sarah Kaiser

Jared Berezin

Amy Loomis

Eric Statz

Joe Edwards

Sebastien Mannai

Guillaume Saint-Jacques

Jeff Mekler

Audren Cloitre

Kento Masuyama

Frederick Moore

Sergeant McTague

Steven Banzaert

Juergen Schoenstein

Jeremy Van Hill

Michael Miller

Riverside Motorsports

Advanced Circuits

Charles Guan

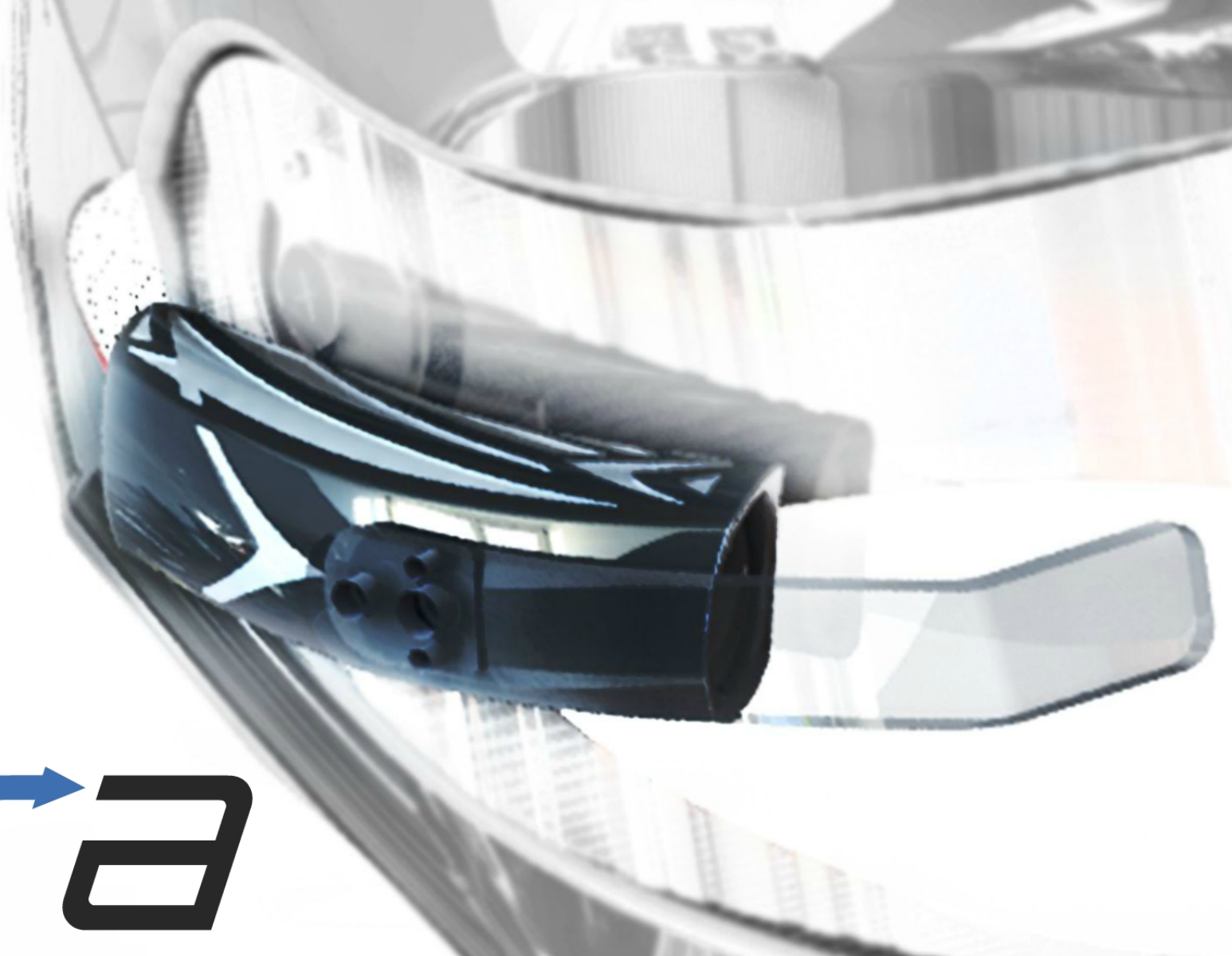

mira